

# Genie®



## **Operator's Manual** *with Maintenance Information*

First Edition  
Third Printing  
Part No. 72896

### **TMZ™-50/30**

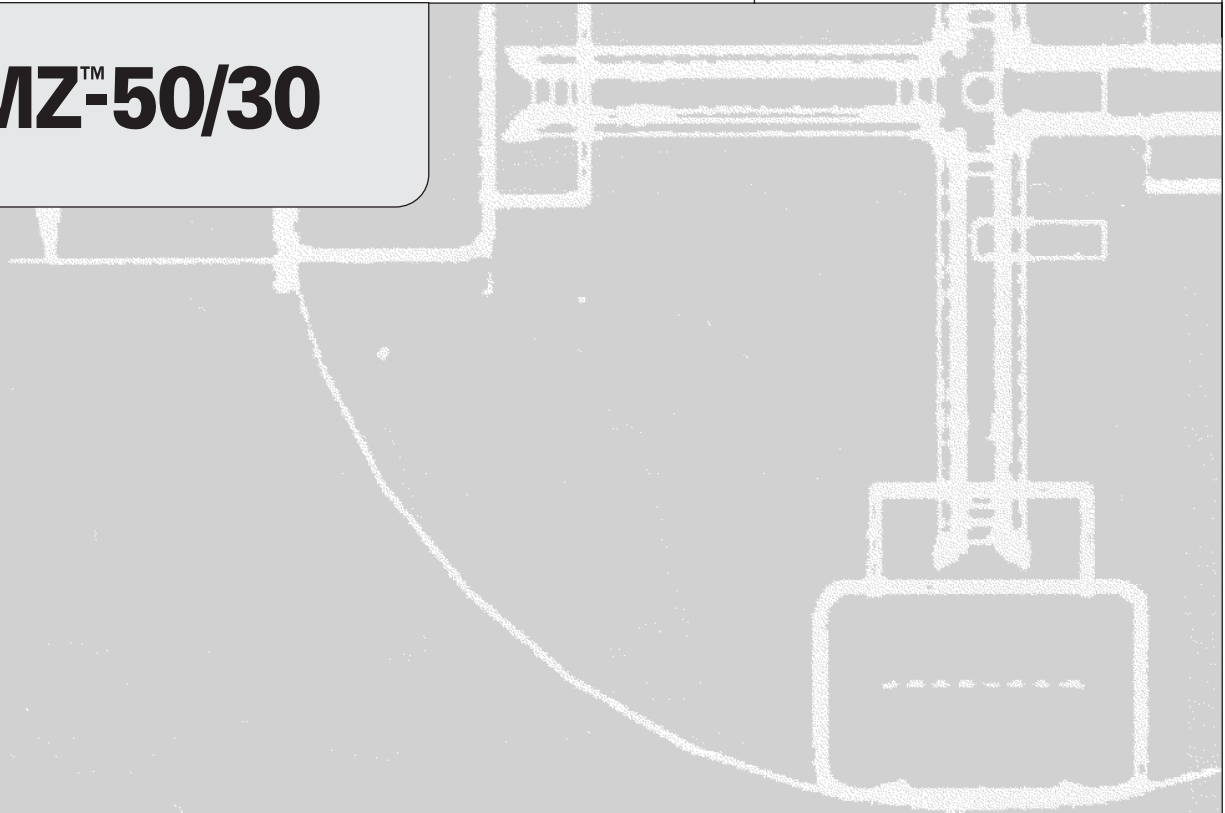

---

## Important

Read, understand and obey these safety rules and operating instructions before operating this machine. Only trained and authorized personnel shall be permitted to operate this machine. This manual should be considered a permanent part of your machine and should remain with the machine at all times. If you have any questions, call Genie Industries.

---

## Contents

	Page
Safety .....	1
Controls .....	9
Pre-operation Inspection .....	12
Maintenance .....	14
Function Tests .....	17
Work Place Inspection .....	20
Operating Instructions .....	21
Decals .....	28
Specifications .....	30
Reporting Safety Defects .....	31

---

## Contact us:

Internet: <http://www.genielift.com>  
 e-mail: [techpub@genieind.com](mailto:techpub@genieind.com)

---

Copyright © 1999 by Genie Industries

First Edition: Third Printing, November 2001

"Genie" and "TMZ" are registered trademarks of Genie Industries in the USA and many other countries.

These machines comply with ANSI/SIA 92.2-1990.



Printed on recycled paper

Printed in U.S.A.

---

# Safety Rules



---

## Danger

Failure to obey the instructions and safety rules in this manual will result in death or serious injury.

---

## Do Not Operate Unless:

- You learn and practice the principles of safe machine operation contained in this operator's manual.
  - 1 Avoid hazardous situations.**
  - Know and understand the safety rules before going on to the next section.**
  - 2 Always perform a pre-operation inspection.
  - 3 Always perform function tests prior to use.
  - 4 Inspect the workplace.
  - 5 Only use the machine as it was intended.
- You read, understand and obey:
  - Manufacturer's instructions and safety rules—safety and operator's manuals and machine decals
  - employer's safety rules and worksite regulations
  - applicable governmental regulations
- You** are properly trained to safely operate the machine.

SAFETY RULES

### Electrocution Hazards

This machine is **not** electrically insulated and will **not** provide protection from contact with or proximity to electrical current.

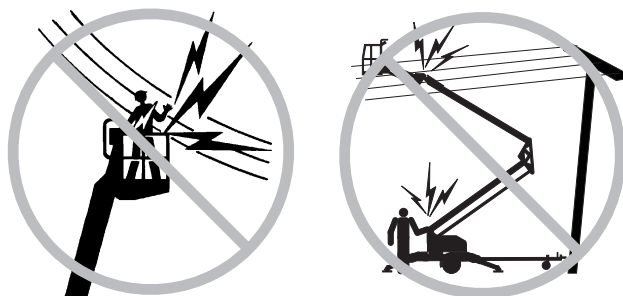

Maintain safe distances from electrical power lines and apparatus in accordance with applicable governmental regulations and the following chart.

Voltage Phase to Phase	Minimum Safe Approach Distance	
	Feet	Meters
0 to 300V	Avoid Contact	
300V to 50KV	10	3.05
50KV to 200KV	15	4.60
200KV to 350KV	20	6.10
350KV to 500KV	25	7.62
500KV to 750KV	35	10.67
750KV to 1000KV	45	13.72

Allow for platform movement, electrical line sway or sag, and beware of strong or gusty winds.

Keep away from the machine if it contacts energized power lines. Personnel on the ground or in the platform must not touch or operate the machine until energized power lines are shut off.

Do not operate the machine during lightning or storms.

Do not use the machine as a ground for welding.

### Tip-over Hazards

Occupants and equipment shall not exceed the maximum platform capacity.

Maximum platform capacity		
ANSI & CE models	500 lbs	227 kg
CSA models	440 lbs	200 kg
Maximum platform capacity with Optional Platform Rotate		
ANSI & CE models	440 lbs	200 kg
CSA models		not available
Maximum occupants		2

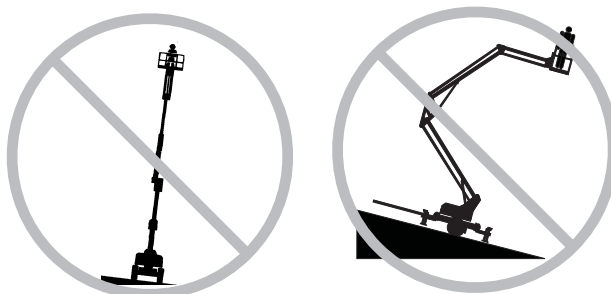

Do not raise or extend the boom unless the machine is level. Do not set the machine up on a surface where it cannot be leveled using only the leveling jacks. Do not use chocks, blocks or shims of any kind to level the machine.

Do not raise or extend the boom unless all four outriggers are lowered and locked, the footpads are in firm contact with the ground and the machine is level.

Do not adjust or stow the outriggers when the boom is raised or extended.

Do not operate the machine near drop-offs, holes, bumps, debris, unstable or slippery surfaces or other possible hazardous conditions.

## SAFETY RULES

Do not move the machine when the boom is raised or extended.

Do not depend on the tilt alarm as a level indicator. The tilt alarm sounds in the platform only when the machine is on a severe slope.

If the tilt alarm sounds, immediately lower the boom and adjust the outriggers to level the machine. When the alarm sounds, boom up functions will not operate.

Do not alter or disable the limit switch(es).



Do not operate the machine in strong or gusty winds. Do not increase the surface area of the platform or the load. Increasing the area exposed to the wind will decrease machine stability.

Do not alter or disable machine components that in any way affect safety and stability.

Do not replace items critical to machine stability with items of different weight or specification.

Do not modify or alter an aerial work platform. Mounting attachments for holding tools or other materials onto the platform, toeboards or guard rail system can increase the weight in the platform and the surface area of the platform or load.

Do not place ladders or scaffolds in the platform or against any part of this machine.

Do not use the machine on a moving or mobile surface or vehicle.

Be sure all tires are properly inflated and in good condition and lug nuts are properly tightened.

Models with batteries: Do not use batteries that weigh less than the original equipment. Batteries are used as counterweight and are critical to machine stability. Each battery must weigh 75 pounds / 34 kg.

Do not push the machine or other objects with the boom.

Do not contact adjacent structures with the boom.

Do not tie the boom or platform to adjacent structures.

### Bodily Injury Hazard

Do not operate the machine with a hydraulic oil or air leak. An air leak or hydraulic leak can penetrate and/or burn skin.

Models with engines: Always operate the machine in a well-ventilated area to avoid carbon monoxide poisoning.

---

## SAFETY RULES

### Collision Hazards

Be aware of boom position when rotating the turntable.

The machine must be on a level surface or secured before releasing the parking brake.

Use the parking brake to control the speed of the machine when pushing a machine that is not attached to a tow vehicle.

Check the work area for overhead obstructions or other possible hazards.

It is recommended that operators wear an approved hard hat when operating the machine.

Do not lower the boom unless the area below is clear of personnel and obstructions.

Do not operate a boom in the path of any crane unless the controls of the crane have been locked out and/or precautions have been taken to prevent any potential collision.

No stunt driving or horseplay while operating the machine.

### Component Damage Hazards

Do not use the machine as a ground for welding.

Do not fully lower the booms unless the booms are aligned with the tongue. The booms must be lowered onto the boom rests.

Do not use any battery or charger greater than 12V to jump-start the engine.

### Lifting Hazards

Use proper lifting techniques to move the machine.

Use proper lifting techniques when installing or removing the platform.

### Explosion and Fire Hazards

Do not start the engine if you smell or detect liquid petroleum gas (LPG), gasoline, diesel fuel or other explosive substances.

Do not refuel the machine with the engine running.

Refuel the machine and charge the battery only in an open, well-ventilated area away from sparks, flames and lighted tobacco.

Do not operate the machine in hazardous locations or locations where potentially flammable or explosive gases or particles may be present.

## SAFETY RULES

## Damaged Machine Hazards

Do not use a damaged or malfunctioning machine.

Conduct a thorough pre-operation inspection of the machine and test all functions before each work shift. Immediately tag and remove from service a damaged or malfunctioning machine.

Be sure all maintenance has been performed as specified in this manual and the appropriate service manual.

Be sure all decals are legible and in place.

Be sure the operator's, safety and responsibilities manuals are complete, legible and in the storage container located on the platform.

## Towing Hazards

Read, understand and obey all of your tow vehicle manufacturer's recommendations, warnings and instructions before towing this machine.

Do not tow the machine unless the mast is lowered to the horizontal position and the mast hold-down latch is securely locked in place.

Do not overload your tow vehicle. Check the manufacturer's Gross Vehicle Weight Rating (GVWR). To obtain the gross vehicle weight, add the tongue weight of the trailer to the vehicle weight (including vehicle, passengers and cargo).

Do not load cargo on the machine. The TML is not designed to carry any extra cargo.

Be sure the hitch is securely attached to the tow vehicle.

Be sure the safety chains (if required) are securely attached to the tow vehicle.

Be sure that all driving lights are operational.

Be sure all hitch components, lights and mirrors and methods of attaching the trailer to the tow vehicle conform to local, state and federal regulations.

Do not tow the machine on public roads unless it meets all governmental regulations for towing.

Do not exceed 60 mph / 97 km/h. Obey all local and national towing speed laws.

Be sure to chock the wheels of the trailer when parking on a hill.

## SAFETY RULES

## Personnel Lifting Configuration

---

### Tip-over Hazards

Do not use the platform as a crane.

Do not place loads outside the platform perimeter.

Do not place or attach overhanging loads to any part of the platform.



Do not push off or pull toward any object outside of the platform.

---

**Maximum allowable side force**  
90 lbs / 400 N

---

Do not use the platform controls to free a platform that is caught, snagged or otherwise prevented from normal motion by an adjacent structure. All personnel must be removed from the platform before attempting to free the platform using the ground controls.

## Fall Hazards

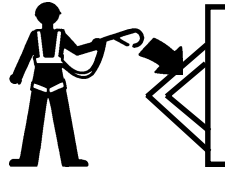

Occupants shall wear a safety belt or harness and comply with applicable governmental regulations. Attach the lanyard to the anchor provided in the platform.

Do not sit, stand or climb on the platform guard rails. Maintain a firm footing on the platform floor at all times.

Do not climb down from the platform when raised.

Keep the platform floor clear of debris.

Lower the platform entry mid-rail or close the entry gate before operating.

## Collision Hazard

Be aware of crushing hazard when grasping the platform guard rail.

## Material Lifting Configuration

---

### Collision Hazards

Do not raise the load unless the material lifting hook is properly secured to the machine.

Do not raise unless the load is properly balanced and secured to the machine.

Do not stand under or allow personnel under the load or the machine when the load is raised.

### Crushing Hazard

Use common sense and planning when operating the machine with the platform controls from the ground. Maintain safe distances between the operator, the machine and fixed objects.



## SAFETY RULES

## Optional Drive System

---

### Tip over Hazards

Use extreme care and slow speeds while driving the machine in the stowed position across uneven terrain, debris, unstable or slippery surfaces and near holes and drop-offs.

### Collision Hazards

Do not drive the machine unless the parking brake on the tongue is set.

Do not drive the machine from the ground. The platform must be fully lowered and the operator must be in the platform.

Be aware of limited sight distance and blind spots when driving or operating.

Observe and use color-coded direction arrows on the platform controls for drive and steer functions.

Limit travel speed according to the condition of the ground surface, congestion, slope, location of personnel, and any other factors which may cause collision.

## Decal Legend

Genie product decals use symbols, color coding and signal words to identify the following:



Safety alert symbol—used to alert personnel to potential personal injury hazards. Obey all safety messages that follow this symbol to avoid possible injury or death.



Red—used to indicate the presence of an imminently hazardous situation which, if not avoided, will result in death or serious injury.



Orange—used to indicate the presence of a potentially hazardous situation which, if not avoided, could result in death or serious injury.



Yellow with safety alert symbol—used to indicate the presence of a potentially hazardous situation which, if not avoided, may cause minor or moderate injury.



Yellow without safety alert symbol—used to indicate the presence of a potentially hazardous situation which, if not avoided, may result in property damage.



Green—used to indicate operation or maintenance information.

## SAFETY RULES

**Battery Safety****Burn Hazards**

Batteries contain acid. Always wear protective clothing and eyewear when working with batteries.

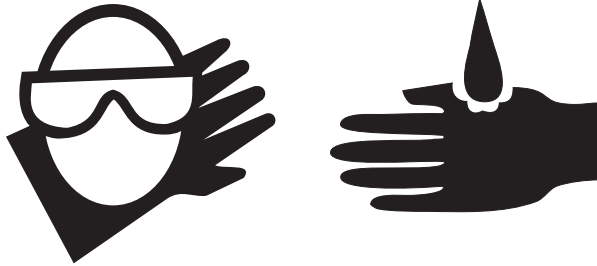

Avoid spilling or contacting battery acid. Neutralize battery acid spills with baking soda and water.

**Explosion Hazards**

Keep sparks, flames and lighted tobacco away from batteries. Batteries emit an explosive gas.

The covers should be open during the entire charging cycle.

Do not contact the battery terminals or the cable clamps with tools that may cause sparks.

**Component Damage Hazards**

Do not use any battery charger greater than 24V to charge the batteries.

Do not expose the batteries or the charger to water or rain.

**Electrocution Hazards**

Connect the battery charger to a grounded, AC 3-wire electrical outlet only.



Inspect daily for damaged cord, cables and wires. Replace damaged items before operating.

Avoid electrical shock from contact with battery terminals. Remove all rings, watches and other jewelry.

**Tip-over Hazard**

Models with batteries: Do not use batteries that weigh less than the original equipment. Batteries are used as counterweight and are critical to machine stability. Each battery must weigh 75 pounds / 34 kg.

**Lifting Hazard**

Use the appropriate number of people and proper lifting techniques when lifting batteries.

# Controls

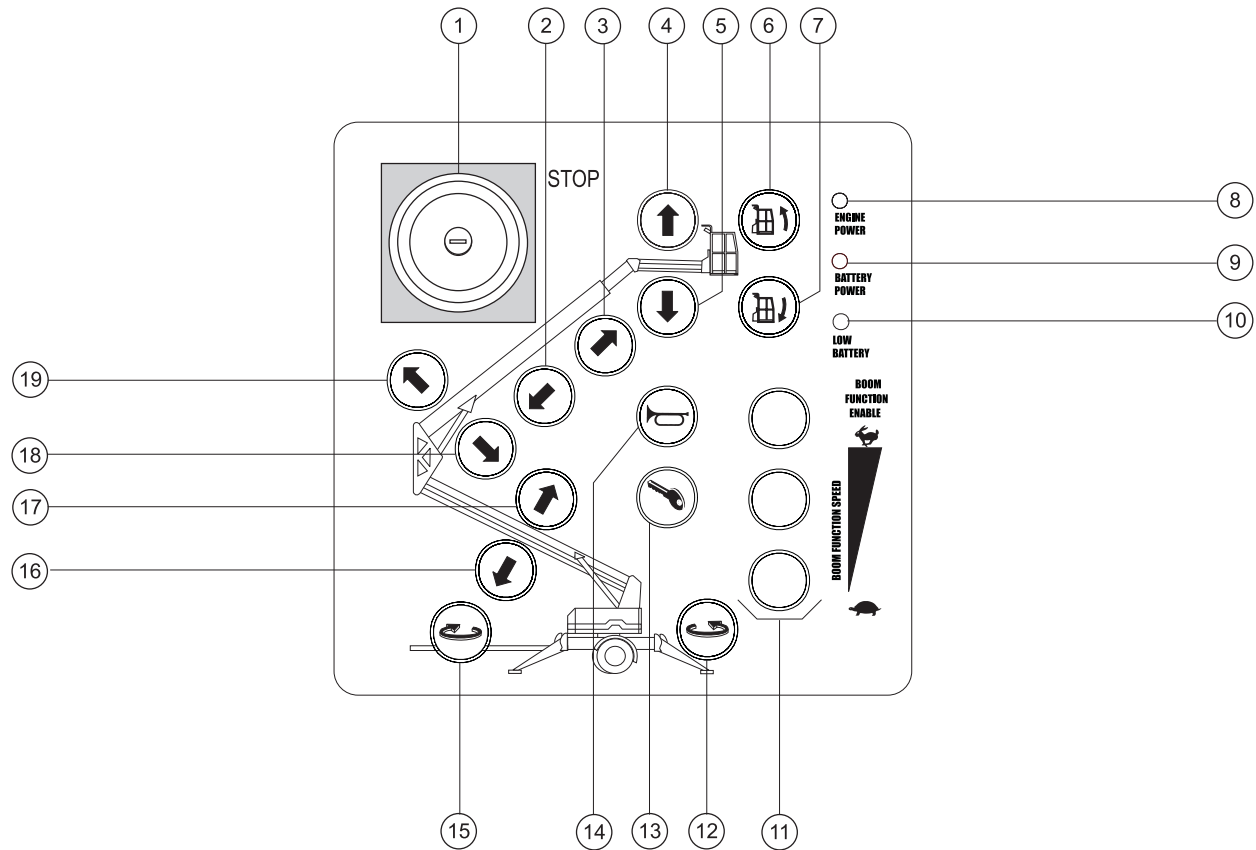

## Platform Control Panel

- |                                 |   |                             |
|---------------------------------|---|-----------------------------|
| 1 Red Emergency Stop button     | 10 Low battery indicator light          | 17 Secondary boom up button |
| 2 Primary boom retract button   | 11 Function enable/speed select buttons | 18 Primary boom down button |
| 3 Primary boom extend button    | 12 Turntable rotate right button        | 19 Primary boom up button   |
| 4 Jib boom up button            | 13 Engine start button                  |                             |
| 5 Jib boom down button          | 14 Horn button                          |                             |
| 6 Platform level up button      | 15 Turntable rotate left button         |                             |
| 7 Platform level down button    | 16 Secondary boom down button           |                             |
| 8 Engine power indicator light  |   |                             |
| 9 Battery power indicator light |   |                             |

Gasoline models with LED diagnostic readout: Choke function is activated by pushing engine start button and slow function speed select button

CONTROLS

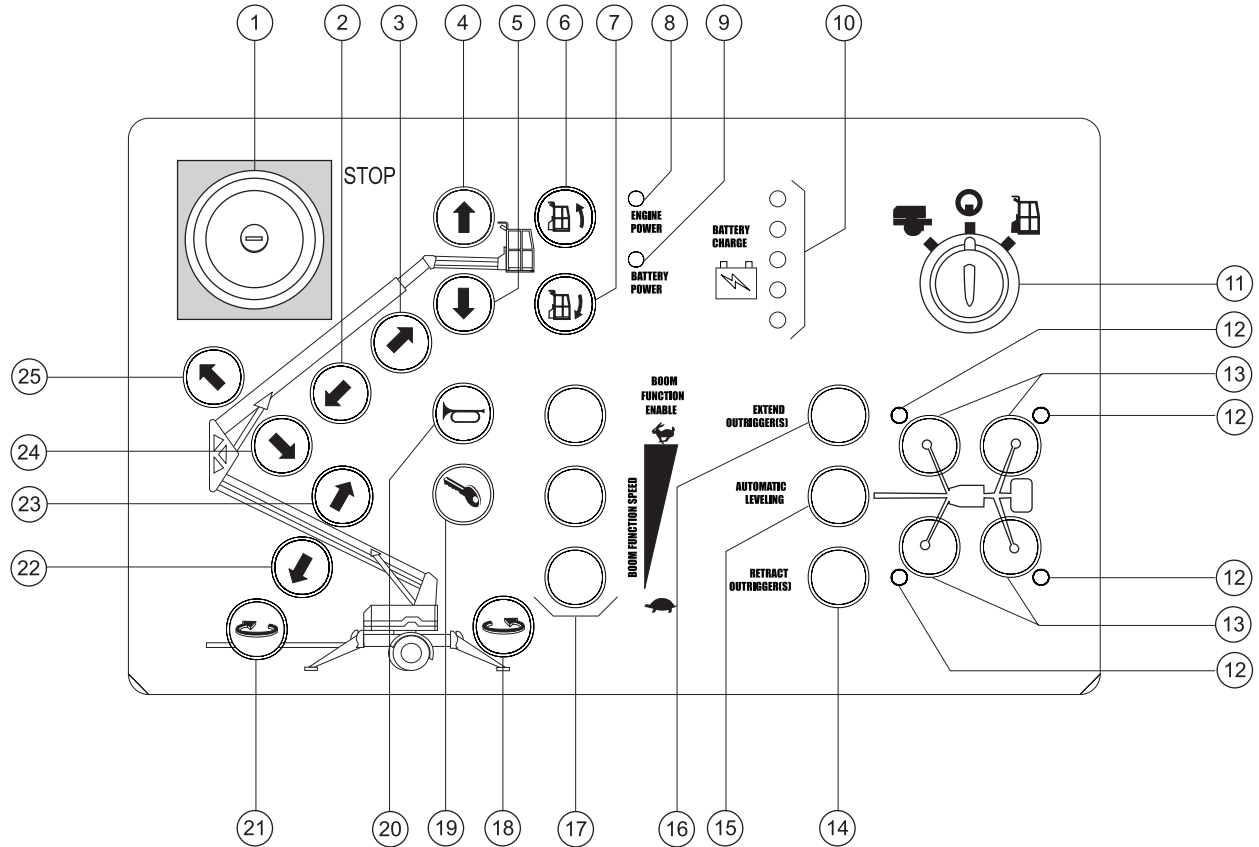

**Ground Control Panel**

- |   |   |   |
|---|---|---|
| 1 Red Emergency Stop button                 | 11 Key switch for ground/off/<br>platform selection | 19 Engine start button  |
| 2 Primary boom retract button               | 12 Outrigger status indicator<br>lights             | 20 Horn button  |
| 3 Primary boom extend button                | 13 Outrigger button                                 | 21 Turntable rotate left button   |
| 4 Jib boom up button                        | 14 Retract outrigger(s) enable<br>button            | 22 Secondary boom down button   |
| 5 Jib boom down button                      | 15 Automatic leveling button                        | 23 Secondary boom up button   |
| 6 Platform level up button                  | 16 Extend outrigger(s) enable<br>button             | 24 Primary boom down button   |
| 7 Platform level down button                | 17 Function enable/speed select<br>buttons          | 25 Primary boom up button   |
| 8 Engine power indicator light              | 18 Turntable rotate right button                    | Gasoline models with LED<br>diagnostic readout: Choke<br>function is activated by pushing<br>engine start button and slow<br>function speed select button |
| 9 Battery power indicator light             |   |   |
| 10 Battery charge level indicator<br>lights |   |   |

CONTROLS

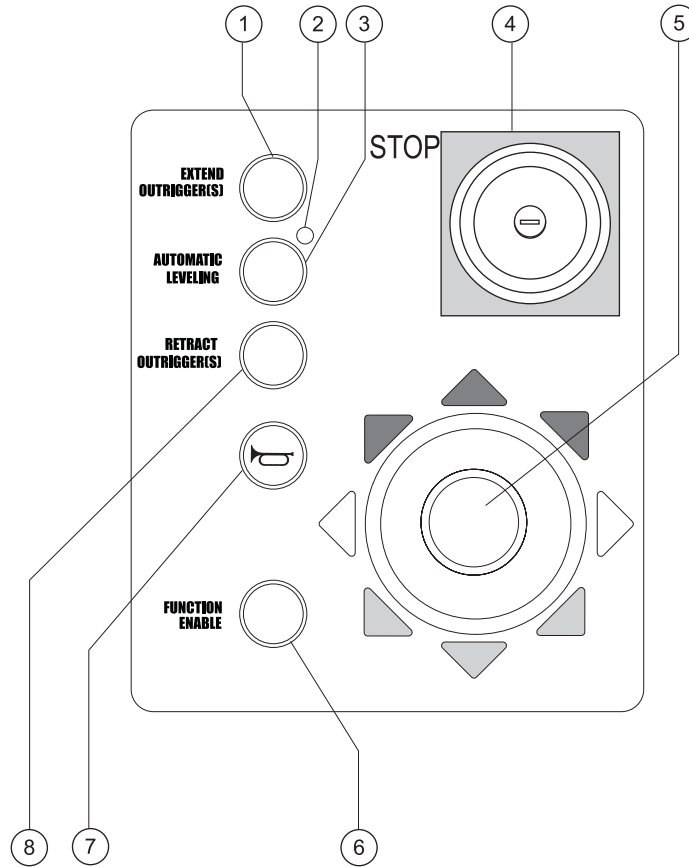

**Drive Control Panel (option)**

- 1 Extend outrigger(s) enable button
- 2 Machine level indicator light
- 3 Automatic leveling button
- 4 Red Emergency Stop button
- 5 Drive and steer controller
- 6 Drive function enable button
- 7 Horn button
- 8 Retract outrigger(s) enable button

# Pre-operation Inspection



---

## Do Not Operate Unless:

- You learn and practice the principles of safe machine operation contained in this operator's manual.

1 Avoid hazardous situations.

**2 Always perform a pre-operation inspection.**

**Know and understand the pre-operation inspection before going on to the next section.**

3 Always perform function tests prior to use.

4 Inspect the workplace.

5 Only use the machine as it was intended.

## Fundamentals

It is the responsibility of the operator to perform a Pre-operation Inspection and routine maintenance.

The Pre-operation Inspection is a visual inspection performed by the operator prior to each work shift. The inspection is designed to discover if anything is apparently wrong with a machine before the operator performs the function tests.

The Pre-operation inspection also serves to determine if routine maintenance procedures are required. Only routine maintenance items specified in this manual may be performed by the operator.

Refer to the list on the next page and check each of the items and locations for modifications, damage or loose or missing parts.

A damaged or modified machine must never be used. If damage or any variation from factory delivered condition is discovered, the machine must be tagged and removed from service.

Repairs to the machine may only be made by a qualified service technician, according to the manufacturer's specifications. After repairs are completed, the operator must perform a pre-operation inspection again before going on to the function tests.

Scheduled maintenance inspections shall be performed by qualified service technicians, according to the manufacturer's specifications and the requirements listed in the responsibilities manual.

## PRE-OPERATION INSPECTION

## Pre-operation Inspection

---

- Be sure that the operator's, safety and responsibilities manuals are complete, legible and in the storage container located on the platform.
- Be sure that all decals are legible and in place. See Decals section.
- Check for hydraulic oil leaks and proper oil level. Add oil if needed. See Maintenance section.
- Models with engines: Check for engine oil leaks and proper fluid level. Add oil if needed. See Maintenance section.
- Check for battery fluid leaks and proper fluid level. Add distilled water if needed. See Maintenance section.
- Check for proper tire pressure and lug nut torque. Add air to tires if needed. See Maintenance section.

Check the following components or areas for damage, modifications and improperly installed or missing parts:

- Electrical components, wiring and electrical cables
- Hydraulic pump(s), reservoir, hoses, fittings, cylinders and manifolds
- Fuel tank (if equipped)
- Engine and related components (if equipped)
- Boom components and wear pads
- Tires and wheels
- Trailer lights and reflectors
- Parking brake components
- Outriggers and foot pads
- Alarms and horn
- Nuts, bolts and other fasteners

- Platform entry mid-rail/gate
- Surge brake components (if equipped)
- Safety chains (if required)
- Mechanical brake components (if equipped)
- Beacon and alarms (if equipped)

Check entire machine for:

- Cracks in welds or structural components
- Dents or damage to machine
- Be sure that all structural and other critical components are present and all associated fasteners and pins are in place and properly tightened.
- Be sure that the machine is properly configured for use.  
Personnel lifting configuration: Be sure the platform is properly installed.  
Material lifting configuration: Be sure the material lifting hook is properly installed.
- Be sure that the batteries are in place and properly connected.
- Models equipped with hydraulic surge brake systems: Check the hydraulic oil level in the surge brake. Check for leaks.
- After you complete your inspection, be sure that all compartment covers are in place and latched.

# Maintenance



## Observe and Obey:

- ☑ Only routine maintenance items specified in this manual shall be performed by the operator.
- ☑ Scheduled maintenance inspections shall be completed by qualified service technicians, according to the manufacturer's specifications and the requirements specified in the responsibilities manual.

## Maintenance Symbols Legend

### NOTICE

The following symbols have been used in this manual to help communicate the intent of the instructions. When one or more of the symbols appear at the beginning of a maintenance procedure, it conveys the meaning below.



Indicates that tools will be required to perform this procedure.



Indicates that new parts will be required to perform this procedure.

## Check the Hydraulic Oil Level



Maintaining the hydraulic oil at the proper level is essential to machine operation. Improper hydraulic oil levels can damage hydraulic components. Daily checks allow the inspector to identify changes in oil level that might indicate the presence of hydraulic system problems.

- 1 Be sure the boom is in the stowed position and the outriggers are retracted.
  - 2 Visually inspect the oil level in the hydraulic tank.
- ⦿ Result: The hydraulic oil level should be 3 inches / 7.6 cm from the top of tank.

---

### Hydraulic oil specifications

---

Hydraulic oil type	Dexron equivalent

---



MAINTENANCE

## Check the Engine Oil Level - Engine Models



Maintaining the proper engine oil level is essential to good engine performance and service life. Operating the machine with an improper oil level can damage engine components.

**NOTICE** Check the oil level with the engine off.

- 1 Check the oil level dipstick.
- ⦿ Result: The oil level should be at the FULL mark on the dipstick. Add oil as needed.

---

### Honda GX340K1 Engine Oil viscosity requirements

Temperature below 60°F / 15.5°C	5W-30
-10°F to 90° / -23°C to 32°C	10W-30
Temperature above -10°F / -23°C	10W-40 to 10W-50
Temperature above 20°F / -6.6°C	20W-40 or 20W-50

Use oils meeting API classification SG (labeled SG/CC or SG/CD) as they offer improved wear protection. Units ship with 10W-40 SG/CC

---

### Hatz 1B30 Engine Oil viscosity requirements

Temperature below 60°F / 15.5°C (synthetic)	5W-30
-10°F to 90° / -23°C to 32°C	10W-40
Temperature above -4°F / 34°C	15W-40

Engine oil should have properties of API classification CD, CE, CF or CG grades. Units ship with 10W-40 SG/CC

---

## Check the Batteries



Proper battery condition is essential to good engine performance and safe operation. Improper fluid levels or damaged cables and connections can result in engine component damage and hazardous conditions.

**NOTICE** This procedure does not need to be performed on machines with sealed or maintenance-free batteries.

**WARNING** Bodily injury hazard. Batteries contain acid. Avoid spilling or contacting battery acid. Neutralize battery acid spills with baking soda and water.

- 1 Put on protective clothing and eye wear.
- 2 Be sure that the battery cable connections are tight and free of corrosion.
- 3 Be sure that the battery hold-down straps are in place and secure.
- 4 Remove the battery vent caps.
- 5 Check the battery acid level. If needed, replenish with distilled water to the bottom of the battery fill tube. Do not overfill.
- 6 Install the vent caps.

## MAINTENANCE

## Check the Tires and Wheels



**⚠ WARNING** Bodily injury hazard. An over-inflated tire can explode and may cause death or serious injury.

**⚠ WARNING** Collision Hazard. An excessively worn tire can cause poor handling and continued use could result in tire failure.

**⚠ WARNING** Tip-over hazard. Do not use temporary flat tire repair products.

Maintaining the tires and wheels in good condition is essential to safe operation and good performance. Tire and/or wheel failure could result in a machine tip-over. Component damage may also result if problems are not discovered and repaired in a timely fashion.

- 1 Check the tire surface and sidewalls for cuts, cracks, punctures and uneven or excessive tread wear.
- ⦿ Result: Replace the tire if uneven or excessive tread wear is found.

**NOTICE** Tires and wheels must be replaced with tires and wheels of the specifications listed.

- 2 Check each wheel for damage, bends and cracks.
- ⦿ Result: Replace the wheel if any damage is found.
- 3 Check each tire with an air pressure gauge and add air as needed.
  - 4 Check the torque of each lug nut.

**Tires and wheels - ANSI & CSA**

Tire size	8-14.5LT	
Lug nut torque	80 ft-lbs	108 Nm
Tire pressure (cold)	100 psi	6.9 bar

**Tires and wheels - CE**

Tire size	215 R14 C 112/110	
Lug nut torque	80 ft-lbs	108 Nm
Tire pressure (cold)	65 psi	4.5 bar

## Scheduled Maintenance

Maintenance performed quarterly, annually and every two years must be completed by a person trained and qualified to perform maintenance on this machine according to the procedures found in the service manual for this machine.

Machines that have been out of service for more than three months must receive the quarterly inspection before they are put back into service.

# Function Tests



## Do Not Operate Unless:

- You learn and practice the principles of safe machine operation contained in this operator's manual.

- 1 Avoid hazardous situations.
- 2 Always perform a pre-operation inspection.

### **3 Always perform function tests prior to use.**

#### **Know and understand the function tests before going on to the next section.**

- 4 Inspect the workplace.
- 5 Only use the machine as it was intended.

## Fundamentals

The Function Tests are designed to discover any malfunctions before the machine is put into service. The operator must follow the step-by-step instructions to test all machine functions.

A malfunctioning machine must never be used. If malfunctions are discovered, the machine must be tagged and removed from service. Repairs to the machine may only be made by a qualified service technician, according to the manufacturer's specifications.

After repairs are completed, the operator must perform a pre-operation inspection and function tests again before putting the machine into service.

## Function Tests

- 1 Be sure the boom hold-down latches are unlatched.

### Setup

- 2 Position the machine below the desired work area.
- 3 Set the parking brake.
- 4 Insert the key and turn to ground control.
- 5 Pull out the red Emergency Stop buttons at the ground and platform controls.  
Models with optional drive system: Also pull out the red Emergency Stop button on the drive control panel.
- ⦿ Machines with LED diagnostic readout: LED should read ----.

Note: Machines with LED diagnostic readout perform a self-check when the power is turned on. The self-check takes about 5 seconds. Do not touch the buttons of the ground control panel until the self-check is done.

- 6 Push and hold the auto-level button. Push and hold the extend outrigger button. The outriggers will lower and adjust to level the machine and raise the wheels slightly off the ground. Level the machine using only the outriggers. Do not use chocks, blocks or shims of any kind to level the machine.

## FUNCTION TESTS

- 7 Check the interlock display. Be sure that all four interlock display lights are on.
- 8 Start the engine (if equipped). See Operating Instructions section.

**At the Ground Controls****Test Emergency Stop**

- 9 Push in the red Emergency Stop button to the OFF position.
  - ⦿ Result: The engine (if equipped) should turn off. All ground and platform control functions should not operate.
- 10 Pull out the red Emergency Stop button to the ON position.

**Test Outrigger Interlock**

- 11 Start the engine (if equipped).
- 12 Push and hold an outrigger button and push and hold the retract outrigger button to raise one outrigger until the corresponding interlock display light turns off.
- 13 Activate the boom functions.
  - ⦿ Result: Boom functions should not operate.
- 14 Push and hold the auto-level button. Push and hold the extend outrigger button. The outriggers will lower and adjust to level the machine and raise the wheels slightly off the ground.
- 15 Repeat the procedure for each outrigger.

**Test the Boom Functions**

- 16 Do not hold a function enable/speed select button. Attempt to activate each boom function button.
  - ⦿ Result: All boom functions should not operate.
- 17 Press and hold a function enable/speed select button. Activate each boom function button.
  - ⦿ Result: All boom functions should operate through a full cycle.

**Test the Tilt Sensor**

- 18 Raise the jib boom approximately 6 inches / 15 cm. Raise the primary boom approximately 6 inches / 15 cm off the boom rest. Raise the secondary boom approximately 6 inches / 15 cm off the boom rest. Extend the primary boom approximately 12 inches / 30 cm.

- 19 Locate the tilt sensor on the chassis near the ground controls.
- 20 Press down one side of the tilt sensor and place the tilt sensor test tool under one of the posts.

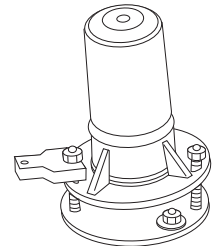

- ⦿ Result: The alarm, located in the platform, should sound after 1 second. The interlock display light should flash.
- 21 Test all ground and platform control functions.
    - ⦿ Result: The primary boom up, the secondary boom up, the jib boom up and the primary extend functions should not operate. The primary boom down, the secondary boom down, the jib boom down, the primary boom retract and the rotate functions should operate normally.
  - 22 Remove the tilt sensor test tool.

## FUNCTION TESTS

**At the Platform Controls**

23 Turn the key switch to platform control.

Note: Machines with LED diagnostic readout perform a self-check when the power is turned on. The self-check takes about 5 seconds. Do not touch the buttons of the platform control panel until the self-check is done.

**Test Emergency Stop**

24 Push in the platform red Emergency Stop button to the OFF position.

- ⦿ Result: The engine (if equipped) should turn off. All ground and platform control functions should not operate.

**Test the Horn**

25 Start the engine (if equipped).

26 Push the horn button.

- ⦿ Result: The horn should sound.

**Test Machine Functions**

27 Press and hold a function enable/speed select button.

28 Activate each boom function button.

- ⦿ Result: All boom functions should operate through a full cycle.

**Test the Drive and Steering (If equipped)**

29 Slowly move the drive control handle in the direction indicated by the blue arrow on the control panel until the machine begins to move, then return the handle to the center position.

- ⦿ Result: The machine should move in the direction that the blue arrow points on the drive chassis, then come to an abrupt stop.

30 Slowly move the drive control handle in the direction indicated by the yellow arrow on the control panel until the machine begins to move, then return the handle to the center position.

- ⦿ Result: The machine should move in the direction that the yellow arrow points on the drive chassis, then come to an abrupt stop.

Note: The parking brake must be able to hold the machine on any slope it is able to climb.

# Workplace Inspection



---

## Do Not Operate Unless:

- You learn and practice the principles of safe machine operation contained in this operator's manual.

- 1 Avoid hazardous situations.
- 2 Always perform a pre-operation inspection.
- 3 Always perform function tests prior to use.

### 4 Inspect the workplace.

**Know and understand the workplace inspection before going on to the next section.**

- 5 Only use the machine as it was intended.

## Fundamentals

The Workplace Inspection helps the operator determine if the workplace is suitable for safe machine operation. It should be performed by the operator prior to moving the machine to the workplace.

It is the operator's responsibility to read and remember the workplace hazards, then watch for and avoid them while moving, setting up and operating the machine.

## Workplace Inspection

Be aware of and avoid the following hazardous situations:

- drop-offs or holes
- bumps, floor obstructions or debris
- overhead obstructions and high voltage conductors
- hazardous locations
- inadequate surface support to withstand all load forces imposed by the machine
- wind and weather conditions
- the presence of unauthorized personnel
- other possible unsafe conditions

# Operating Instructions



## Do Not Operate Unless:

- You learn and practice the principles of safe machine operation contained in this operator's manual.
  - 1 Avoid hazardous situations.
  - 2 Always perform a pre-operation inspection.
  - 3 Always perform function tests prior to use.
  - 4 Inspect the workplace.
  - 5 Only use the machine as it was intended.**

## Fundamentals

The Operating Instructions section provides instructions for each aspect of machine operation. It is the operator's responsibility to follow all the safety rules and instructions in the operator's, safety and responsibilities manuals.

Using the machine for anything other than lifting personnel and tools to an aerial work site is unsafe and dangerous.

Only trained and authorized personnel should be permitted to operate a machine. If more than one operator is expected to use a machine at different times in the same work shift, they must all be qualified operators and are all expected to follow all safety rules and instructions in the operator's, safety and responsibilities manuals. That means every new operator should perform a pre-operation inspection, function tests, and a workplace inspection before using the machine.

## Emergency Stop

Push in the red Emergency Stop button to the OFF position to stop all ground and platform control functions.

Repair any function that operates from the ground or platform controls when the Emergency Stop button at the ground controls is pushed in.

Repair any function that operates from the platform when the Emergency Stop button at the platform controls is pushed in.

## Set up

- 1 Position the machine directly below the desired work area.
- 2 Set the parking brake.
- 3 Disconnect the trailer lights, chains and surge brake safety cable from the vehicle.
- 4 Open the latch on the ball coupler.
- 5 Pull the jack release handle and rotate the tongue jack to the lifting position.
- 6 Raise the tongue by turning the jack handle.
- 7 Open all boom hold-down latches.
- 8 Push and hold the auto-level button. Push and hold the extend outrigger button. The outriggers will lower and adjust to level the machine and raise the wheels slightly off the ground.
- 9 Be sure that all four interlock display lights are on at the ground control panel.

---

## OPERATING INSTRUCTIONS

### Transport

- 1 Set the parking brake.
- 2 Secure the boom with the hold-down latches.
- 3 Raise the tongue by turning the jack handle.
- 4 Position the ball of the transport vehicle directly under the ball coupler.
- 5 Open the latch on the ball coupler.
- 6 Lower the tongue by turning the jack handle.
- 7 Close the latch on the ball coupler.
- 8 Attach the chains (if required) and the brake safety cable to the vehicle. Cross the chains under the hitch.
- 9 Pull the jack release handle and rotate the tongue jack to the stowed position.
- 10 Connect and test the trailer lights.
- 11 Release the parking brake.

### Towing Information

Use the checklist provided on the back cover of this manual before towing and while on the road.

Inspect all connections at each stop.

**Driving a vehicle/trailer combination is different from driving a vehicle alone.**

All tires must be properly inflated. Find the recommended cold tire pressures on the tire sidewall or trailer decal. Do not overinflate the tires. Tire pressures go up during driving. Checking the tire pressure when the tires are warm will give you an inaccurate pressure reading.

Increase the distance between your vehicle and the vehicle in front of you to twice the normal following distance when towing a trailer. Allow more following distance in adverse weather.

Slow down for downgrades and shift your transmission into a lower gear.

Slow down for curves, hazardous road conditions, freeway exits, and when driving in adverse weather.

Heavy winds, excessive speed, load shifting or passing vehicles can cause the trailer to sway while driving. If this occurs, do not brake, speed up or turn the steering wheel. Turning the steering wheel or applying the brakes can cause the vehicle and trailer to jackknife. Let up on the gas pedal and keep the steering wheel straight.

If the vehicle and/or trailer travels off the paved road, hold the steering wheel firmly and let up on the gas pedal. Do not apply the brakes. Do not turn sharply. Slow down to under 25 mph / 40 km/h. Gradually turn the steering wheel to get back on the road. Proceed with caution when entering traffic.

When passing other vehicles, be sure to leave enough room for the extra length of the trailer. You will need to go much farther beyond the passed vehicle before you can return to your lane.

Avoid jerky or sudden movements when turning.



## OPERATING INSTRUCTIONS

## Models with Engines - Manual Lowering

When the main power source fails (engine), the Battery Power light will come on and the machine is in auxiliary power mode.

The boom functions will operate at a reduced speed.

Auxiliary power mode is intended for short term use.

## DC Models - Manual Lowering

All boom functions can be operated with the hand pump located under the function manifold side cover.

- 1 Select a function and it's corresponding valve.

### Primary boom retract function

- 1 Push and rotate the valve spool. Operate the hand pump with a push/pull motion.
- 2 Push and rotate the valve spool to return to normal operating mode.

Note: The valve spool must be reset for the boom extend function to operate.

### All other functions

- 1 Manually open the valve by pulling out or pushing in on the end of the valve spool.
- 2 Hold the valve in the open position and operate the hand pump with a push/pull motion.

### Function Manifold

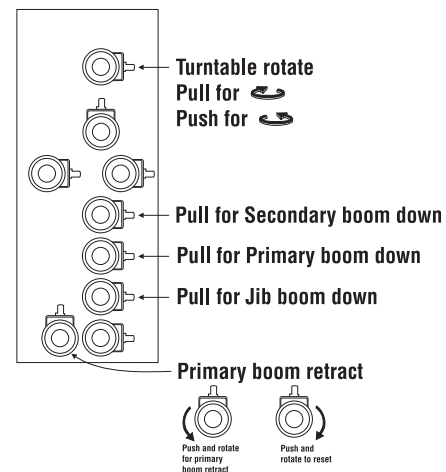

## OPERATING INSTRUCTIONS

## Starting the Engine (if equipped)

- 1 At the ground controls, turn the key switch to the desired position.
- 2 Be sure both ground and platform control red Emergency Stop buttons are pulled out to the ON position.
- 3 Gasoline models: Turn the key switch on the engine to the ON position.  
Diesel models: Turn the key switch on the engine to the vertical position.
- 4 Push the engine start button.

Gasoline models with LED diagnostic readout: To activate the choke, push the engine start button and slow function speed button at the same time. Release the buttons to turn off the choke.

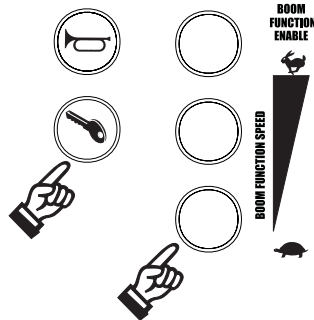

If the engine fails to start after 15 seconds of cranking, determine the cause and repair any malfunction. Wait 60 seconds before trying to start again.

All models: In extreme cold conditions, 20°F / -6°C and below, warm the engine for 5 minutes before operating to prevent hydraulic system damage.

Gasoline models: Turn the key switch on the engine to the OFF position and close the fuel shut-off valve if the machine will be idle.

## Operation from Ground

- 1 Turn the key switch to ground control.
- 2 Pull out the red Emergency Stop button to the ON position.
- 3 DC models: Be sure the batteries are connected before operating the machine.  
Models with engines: Start the engine.

### To Position Platform

- 1 Press and hold a function enable/speed select button.
- 2 Press the appropriate boom function button according to markings on the control panel.

## Operation from Platform

- 1 Turn the key switch to platform control.
- 2 Pull out both ground and platform red Emergency Stop buttons to the ON position.
- 3 Models with batteries: Be sure that the batteries are connected before operating the machine.  
Models with engines: Start the engine.

### To Position Platform

- 1 Press and hold a function enable/speed select button.
- 2 Press the appropriate boom function button according to the markings on the control panel.

- 3 If equipped: Rotate the platform by turning the hand crank in either a clockwise or counterclockwise direction.

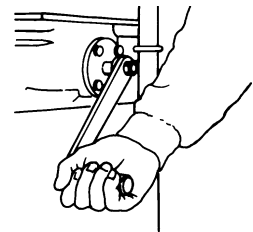

## OPERATING INSTRUCTIONS

## Optional Drive System Operating Instructions

- 1 Be sure the platform is fully lowered. The drive function will not operate unless the platform is fully lowered.
- 2 Set the parking brake on the tongue. The drive function will not operate unless the parking brake is set.
- 3 Push and hold the auto-level button. Push and hold the retract outrigger button. Fully retract the outriggers.
- 4 Press and hold the function enable button.
- 5 Move the drive control off center. Use the color-coded direction arrows on the control panel to determine the direction of machine travel.
- 6 Before raising the platform, lower the outriggers and adjust to level the machine and raise the wheels slightly off the ground.

Note: The machine level indicator light on the drive control panel should be on.

## Backing Up with Trailer (if equipped with surge brake)

The surge brake system must be released before backing up.

Consult the surge brake system manual for specific instructions on each surge brake.

Be sure that the machine is returned to towing or operating configuration when finished.

## Transport (not attached to a tow vehicle)

Use the parking brake to control the speed of the machine when pushing a machine that is not attached to a tow vehicle.

## After Each Use

- 1 Select a safe parking location—firm level surface, clear of obstruction and traffic.
- 2 Rotate the turntable so that the platform is opposite the tongue of the machine. Use the black arrows to properly align the turntable.
- 3 Lower the boom to the stowed position.
- 4 Secure the boom with the hold-down latches.
- 5 Turn the key switch to the OFF position and remove the key to secure from unauthorized use.
- 6 Chock the wheels.
- 7 Charge the batteries.

## OPERATING INSTRUCTIONS



## Material Lifting Configuration

---

### Observe and Obey:

- Maintain safe distances between the operator, machine and fixed objects.
- Be aware of the direction the boom will travel when using the platform controls.

## Material Lifting Configuration Set up

- 1 Turn the key switch to the off position.
- 2 Remove the pin that secures the material lifting hook to the base. Remove the material lifting hook.
- 3 Disconnect the platform controls from the platform.
- 4 Remove the platform controls. Open the clamp on the back of the platform controls and slide the controls up and off.
- 5 Open the controls side turntable cover.
- 6 Disconnect the electrical cord on the bottom right side of the ground control box. Connect the platform control cord disconnected in step 3 to the ground control box. Close the turntable cover.
- 7 Support the platform. Remove the toggle pin that secures the platform to the jib boom.
- 8 Lift the platform up and remove it from the machine.
- 9 To install the material lifting hook, insert the bottom rail into the platform mounting bracket and rotate up into position. Insert the toggle pin.
- 10 Operate the material lifting hook from the ground with the platform controls. The key switch should be turned to the platform control position.
- 11 Reverse the above process to install the platform and return the machine to a personnel lifting configuration.

## OPERATING INSTRUCTIONS



## Battery and Charger Instructions

### Observe and Obey:

- ☑ Do not use an external charger or booster battery.
- ☑ Charge the battery in a well-ventilated area.
- ☑ Use proper AC input voltage for charging as indicated on the charger.
- ☑ Use only Genie authorized battery and charger.

### To Charge Battery

- 1 Be sure the batteries are connected before charging the batteries.
- 2 Open the turntable covers. The covers should remain open for the entire charging cycle.
- 3 Remove the battery vent caps and check the battery acid level. If necessary, add only enough distilled water to cover the plates. Do not overfill prior to the charge cycle.
- 4 Replace the battery vent caps.
- 5 Connect the battery charger to a grounded AC circuit.
- 6 Turn the battery charger on.
- 7 The charger will indicate when the battery is fully charged.
- 8 Check the battery acid level when the charging cycle is complete. Replenish with distilled water to the bottom of the fill tube. Do not overfill.

### Dry Battery Filling and Charging Instructions

- 1 Remove the battery vent caps and permanently remove the plastic seal from the battery vent openings.
- 2 Fill each cell with battery acid (electrolyte) until the level is sufficient to cover the plates.

Do not fill to maximum level until the battery charge cycle is complete. Overfilling can cause the battery acid to overflow during charging. Neutralize battery acid spills with baking soda and water.

- 3 Install the battery vent caps.
- 4 Charge the battery.
- 5 Check the battery acid level when the charging cycle is complete. Replenish with distilled water to the bottom of the fill tube. Do not overfill.

### Voltage Conversion

Some battery chargers are equipped with a multifunction fuse, which enables the operator to switch between 110-120 volts and 220-240 volts.

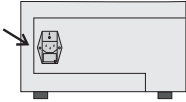
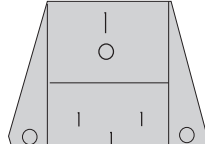
- 1 Locate the fuse drawer module on the front of the battery charger. 
- 2 To change voltage, pull the fuse drawer out, flip it over so the desired voltage range reads right side up, and return the drawer to the slot.
- 3 Check that the triangle next to the desired voltage range points to the triangle printed on the lip of the module. 

# Decals

## Decal Inspection

Use the pictures on the next page to verify that all decals are legible and in place.

Below is a numerical list with quantities and descriptions.

Part No.	Description	Quantity
27564	Danger - Electrocutation Hazard	2
28157	Label - Dexron	1
28158	Label - Unleaded	1
28159	Label - Diesel	1
28161	Warning - Crush Hand	12
28164	Notice - Hazardous Materials	1
28171	Label - No Smoking	1
28174	Power to Platform, 230V	2
28175	Caution - Compartment Access	1
28176	Notice - Missing Manuals	1
28235	Power to Platform, 115V	2
28236	Warning - Failure To Read . . .	1
31060	Danger, Do not alter limit switch	2
35579	Notice - Max Cap, Hook, 500 lbs / 227 kg	1
37052	Notice - Max Cap - 500 lbs / 227 kg	1
40434	Label - Lanyard Anchorage Point	2
43658	Notice - Power to Battery Charger, 230V	1
44248	Notice - Max Capacity - 440 lbs / 200 kg	1
44980	Notice - Power to Battery Charger, 115V	1
44981	Airline to Platform	2
44986	Notice - Side Force 90 lbs / 400N (CE)	1
48719	Danger - General Safety, Platform	1
48723	Label - Parking Brake (surge)	1
48726	Notice - Battery Charger Operating Instructions	1
48727	Danger - Battery/Charger Safety	1
48733	Danger - Tip-over (batteries)	1

Part No.	Description	Quantity
49910	Serial Plate	1
52008	Danger - General Safety, Ground	1
52475	Label - Transport Tie-down	4
52569	Ground Control Panel	1
52829	Genie TMZ-50/30 - Large	1
52830	Genie TMZ-17/10 - Large	1
59625	Platform Control Panel	1
62698	Genie TMZ-50/30 - Small	1
62699	Genie TMZ-17/10 - Small	1
62700	Notice - Operating Instructions, Ground	1
62701	Notice - Operating Instructions, Platform	1
62702	Danger/Notice - Drive System	1
62707	Warning - Towing Hazard	2
62708	Label - Manual Lowering Valves	1
62709	Notice - Material Lifting Operation	1
62713	Notice - Honda Engine Specifications	1
62714	Notice - Hatz Engine Specifications	1
62719	Label - Arrow	2
62722	Notice - Max Capacity - 440 lbs / 200 kg	1
62733	Ground Control Panel	1
62734	Platform Control Panel	1
62735	Notice - Battery Connection Diagram	1
65056	Waterline to Platform	2
65059	Notice - Battery Connection Diagram	1
65309	Notice - Side Force 90 lbs / 400N (ANSI & CSA)	1
72898	Notice - Tire specification, ANSI & CSA	2
72899	Decal - Notice, Transport Instructions	1
72909	Notice - Tire specification, CE	2
72971	Label - Transport to Canada	2
82228	Label - Fault Codes	1
82231	Notice - Battery Connection Diagram	1
82232	Label - LED Diagnostic Readout	1

DECALS

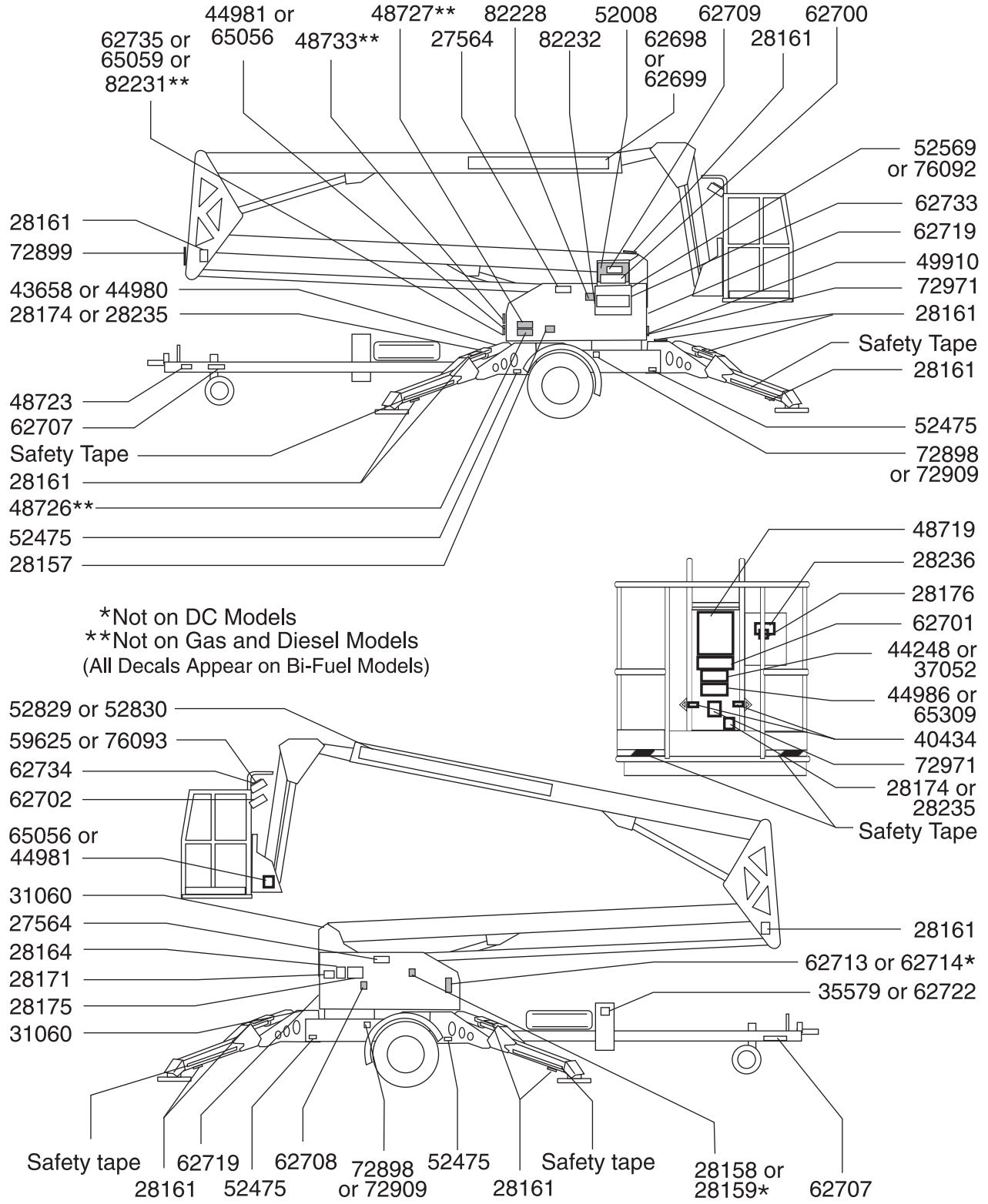

\*Not on DC Models  
 \*\*Not on Gas and Diesel Models  
 (All Decals Appear on Bi-Fuel Models)

# Specifications

Height, working maximum	56 ft 17.2 m	Tire size - ANSI & CSA	8-14.5LT Load Range F
Height, platform maximum	50 ft 15.2 m	Tire size - CE	215 R14 C 112/110
Height, stowed maximum	6 ft 5 <sup>1</sup> / <sub>2</sub> in 1.97 m	Ground clearance	10 in 25.4 cm
Horizontal reach maximum from centerline of machine	28 ft 8.5 m	Hydraulic tank capacity	8 gallons 30.3 liters
Outrigger footprint (w x l)	13 ft 11 in x 14 ft 10 in 4.2 x 4.5 m	Weight (Machine weights vary with option configurations)	See Serial Plate
Maximum load capacity ANSI & CE models	500 lbs 227 kg	Maximum towing speed	60 mph 97 km/h
Maximum load capacity ANSI & CE models with platform rotate	440 lbs 200 kg	Maximum tongue weight ANSI and CSA	490 lbs 222 kg
Maximum load capacity CSA models	440 lbs 200 kg	Maximum tongue weight CE	220 lbs 100 kg
Width	65 in 165 cm	Airborne noise emissions Maximum sound level at normal operating workstations (A-weighted)	70 dB
Length, stowed	22 ft 6 in 6.9 m	<b>Continuous improvement of our products is a Genie policy. Product specifications are subject to change without notice or obligation.</b>	
Turntable rotation	358 degrees		
Power source DC Models	4 Group-L16, 6V 250AH Batteries		
Power source Gasoline Models	Honda GX340 11 Hp		
Power source Diesel Models	Hatz 1B30 7 Hp		
Platform dimensions, (length x width)	48 in x 30 in 1.22 m x 76 cm		
Platform leveling	self-leveling		
AC outlet in platform	standard		



---

# Reporting Safety Defects

**Genie Industries**  
**PO Box 97030**  
**Redmond, WA 98073-9730**

## Reporting Safety Defects

If you believe that your vehicle has a defect which could cause a crash or could cause injury or death, you should immediately inform the National Highway Traffic Safety Administration (NHTSA) in addition to Genie Industries.

If NHTSA receives similar complaints, it may open an investigation, and if it finds that a safety defect exists in a group of vehicles, it may order a recall and remedy campaign. However, NHTSA cannot become involved in any individual problems between you, your dealer or Genie Industries.

To contact NHTSA you may either call the Auto Safety Hotline toll-free at 1-800-424-9393 (366-0123 in Washington DC area) or write to:

**NHTSA**  
**U.S. Department of Transportation**  
**400 7th Street SW, (NSA-11)**  
**Washington DC 20590**

You can also obtain information about motor vehicle safety from the Hotline.

# Towing Checklist

(Use at each stop)

## Before Towing

- Towing hitch and hitch ball are secure
- Safety chains (if required) are properly attached and secure (chains are crossed below hitch)
- All lights are connected and working
- Check all tires for correct pressure

## Before Driving

- Fasten safety restraints
- Properly adjust mirrors

## On The Road

- Do not exceed 60 mph / 97 km/h. Obey all local and national towing speed laws.
- Stop often for rest.
- Inspect vehicles and connections at each stop.
- Anticipate stops; brake early.

### Genie North America

Phone 425.881.1800  
Toll Free USA and Canada  
800.536.1800  
Fax 425.883.3475

### Genie Australia Pty Ltd.

Phone 1 61 7 3375 1660  
Fax 1 61 7 3375 1002

### Genie China

Phone 86 21 53852570  
Fax 86 21 53852569

### Genie Malaysia

Phone 604 228 1235  
Fax 604 226 6872

### Genie Japan

Phone 81 3 3453 6082  
Fax 81 3 3453 6083

### Genie Korea

Phone 82 2 558 7267  
Fax 82 2 558 3910

### Genie Africa

Phone 27 11 455 0373  
Fax 27 11 455 0355

### Genie Latin America

Phone 55 11 4055 2499  
Fax 55 11 4043 1661

### Genie Holland

Phone 31 70 51 78836  
Fax 31 70 51 13993

### Genie Denmark

Phone 45 6612 5544  
Fax 45 6612 5530

### Genie France

Phone 33 2 37 26 09 99  
Fax 33 2 37 26 09 98

### Genie Spain

Phone 34 93 579 5042  
Fax 34 93 579 5059

### Genie Germany

Phone 49 4202 8852-0  
Fax 49 4202 8852-20

### Genie U.K.

Phone 44 1476 584333  
Fax 44 1476 584334

### Genie Mexico City

Phone 52 5 653 03 84  
Fax 52 5 664 40 16

## California Proposition 65

# WARNING

The exhaust from this product contains chemicals known to the State of California to cause cancer, birth defects or other reproductive harm.

Distributed By: